



Communications
Research Centre
Canada

An Agency of
Industry Canada

Centre de recherches
sur les communications
Canada

Un organisme
d'Industrie Canada

Software Defined Radios

RABC Conference
Ottawa, 3 March 2004

Software Defined Radio

- **A wireless system whose operating modes and parameters can be changed or augmented post-manufacturing, via software.**
- *Based on an Open Architecture*

Radio Convergence



**Single
reconfigurable
radio platform**

SDR Evolution

- **Digital radios dates back to the early days of digital signal processors**
 - Protocol capability limited by processor's performance
- **Analog / Digital boundary being pushed towards the antenna with the emergence of higher performance processors**
 - General Purpose Processors (GPP), Digital Signal Processors (DSP), Field Programmable Gate Arrays (FPGA)
 - Analog-to-Digital and Digital-to-Analog converters
- **Re-programmability of devices provides increased radio control and support for multiple waveforms**

SDR Evolution (cont.)

- **Today, waveform implementation is specific to a company, department or even program**
 - Programming languages
 - Operating systems
 - Device interfaces
 - Message formats
- **Limits of today's digital radios**
 - Limited portability of software components from platform to platform
 - Limited code reuse
 - Limited interoperability

SDR Evolution (cont.)

- **SDR must standardize the implementation process**
 - Open standard software architecture
 - To support interoperability, scalability, upgrades
 - Standard service definition
 - Load, setup, monitor, control,...
 - Standard Application Programming Interfaces (API)
- **Software reuse becomes a key factor**

SDR – A Paradigm Shift

- **SDR is a paradigm shift in radio development**
 - **Decouples hardware, software and system integration functions**
 - Facilitates acquisition process by eliminating stovepipe systems
 - **Promotes re-use of signal processing software modules**
 - Modulator, demodulator, encoder, interleaver, FFT...
 - Reduces application development cost
 - **Open framework architecture**
 - “Glues” the software and hardware
 - Facilitates application and module portability
- **SDR is essentially a GPP-enabled digital radio based on an open architecture**

- **Central radio software piece, the “operating system”**
- **Provides an abstraction between software and hardware**
 - Defines interfaces, behavioural specifications and general rules to support devices and application portability
- **Based on commercial standards**
 - X.731 ITU/CCITT OSI System State Management
 - CORBA (Common Object Request Broker Architecture)
 - Posix (Portable Operating System Interfaces)
 - CCM (Corba Component Model)
- **Designed to meet commercial as well as military application requirements**

SDR Components

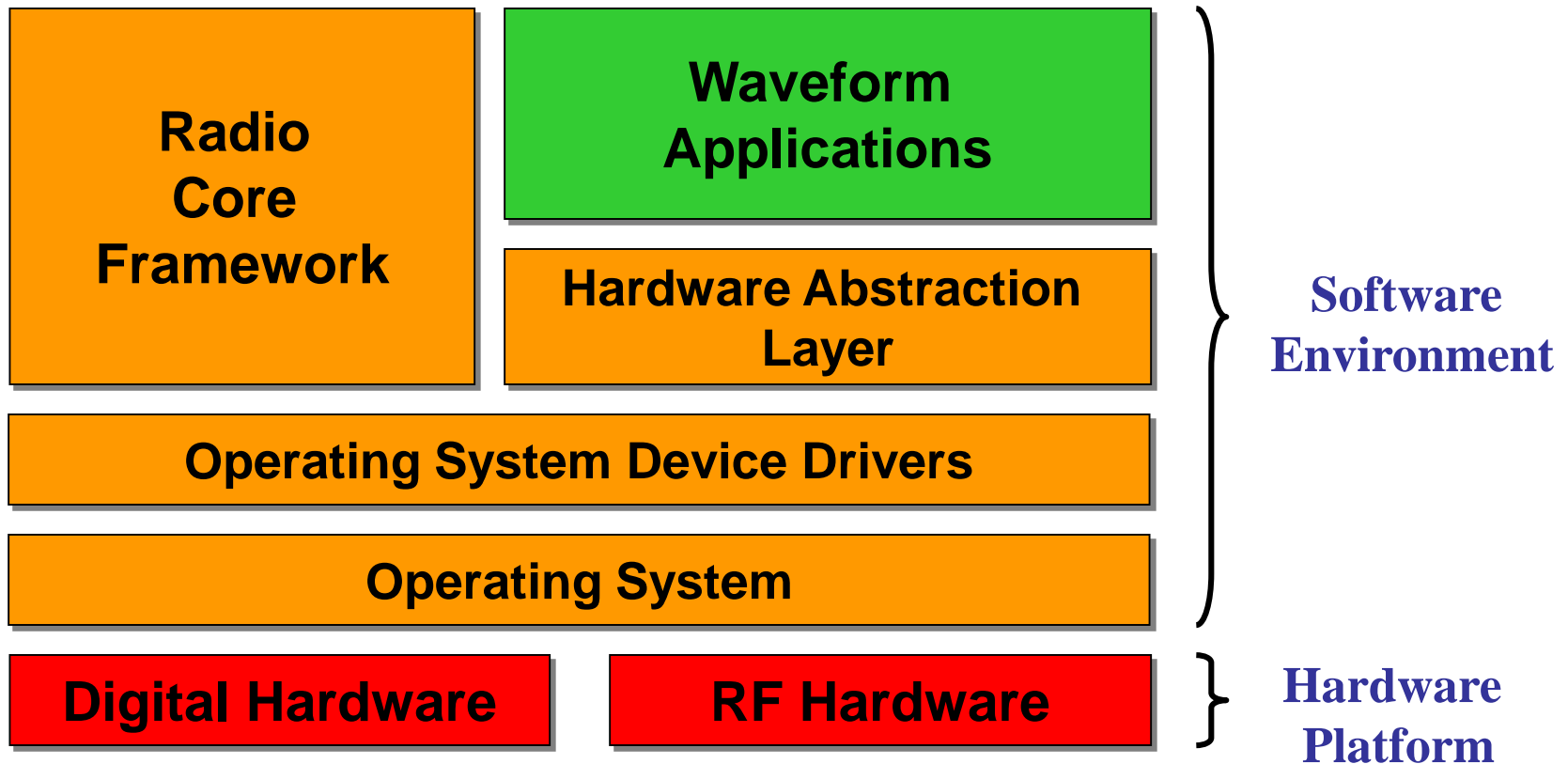

SDR Evolution

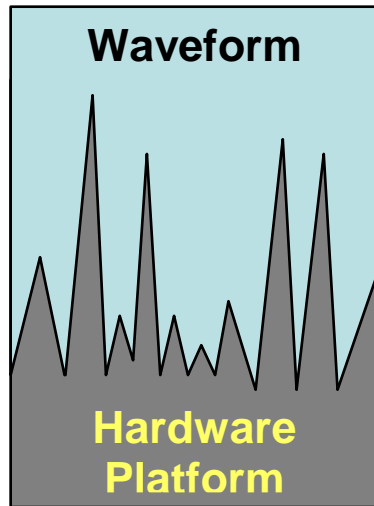

SDR up to now

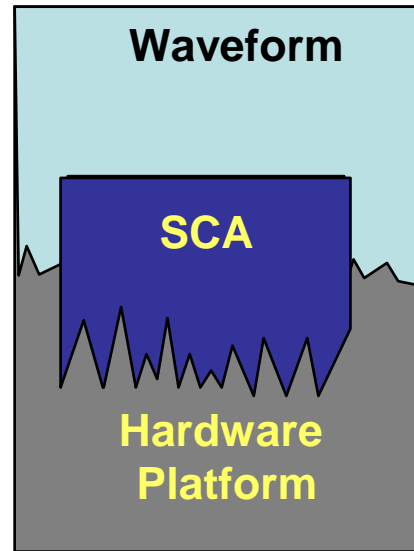

SDR now

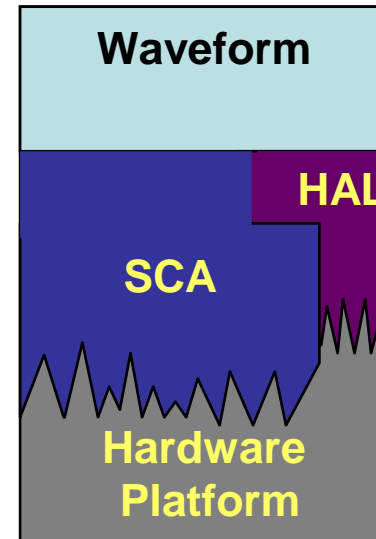

SDR becoming

SCA Design Concept

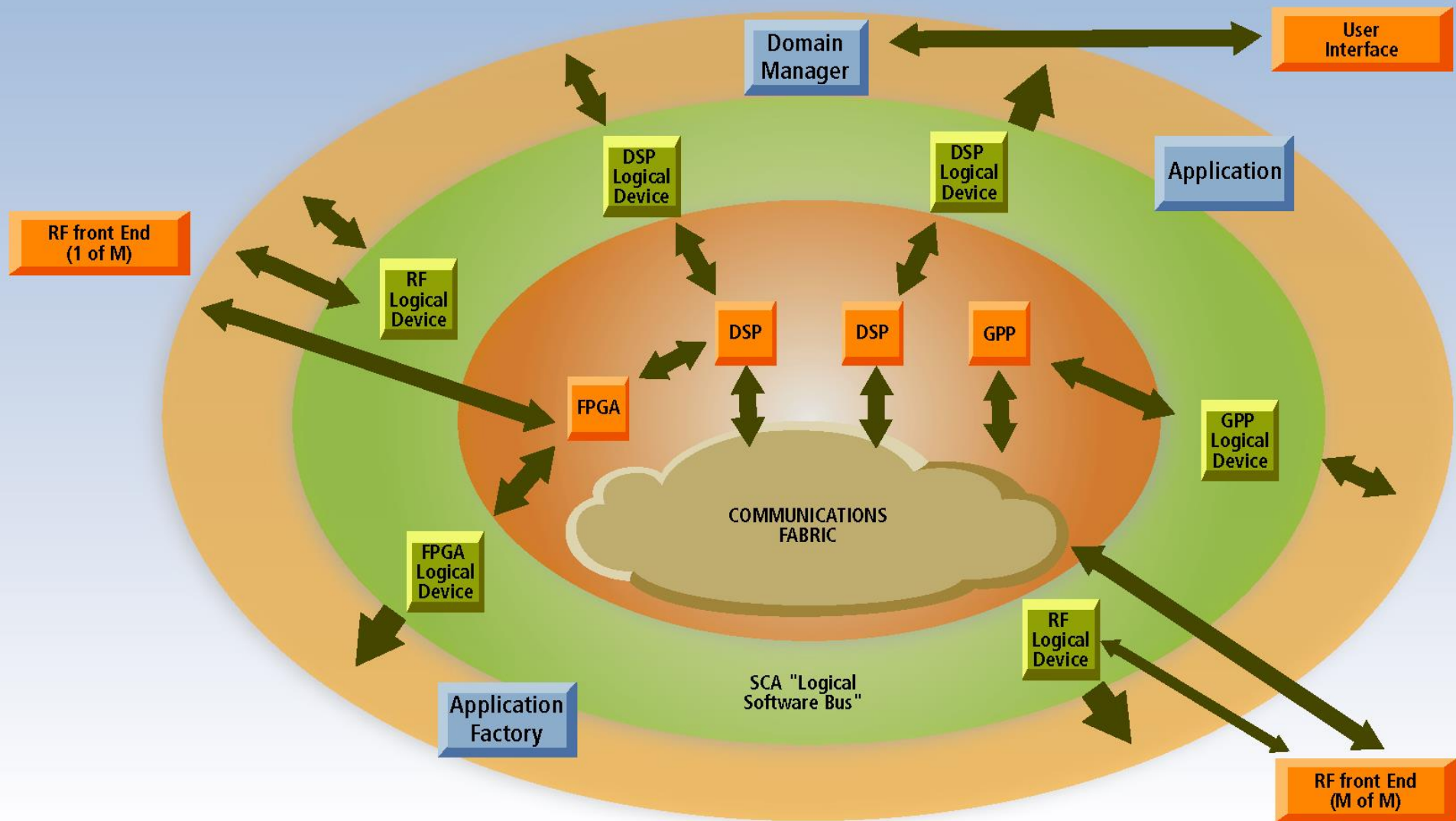

SCA Platform

For the platform developer, the SCA is composed of three major types of components:

- *Domain Manager*
- *Device Manager*
- *Device*

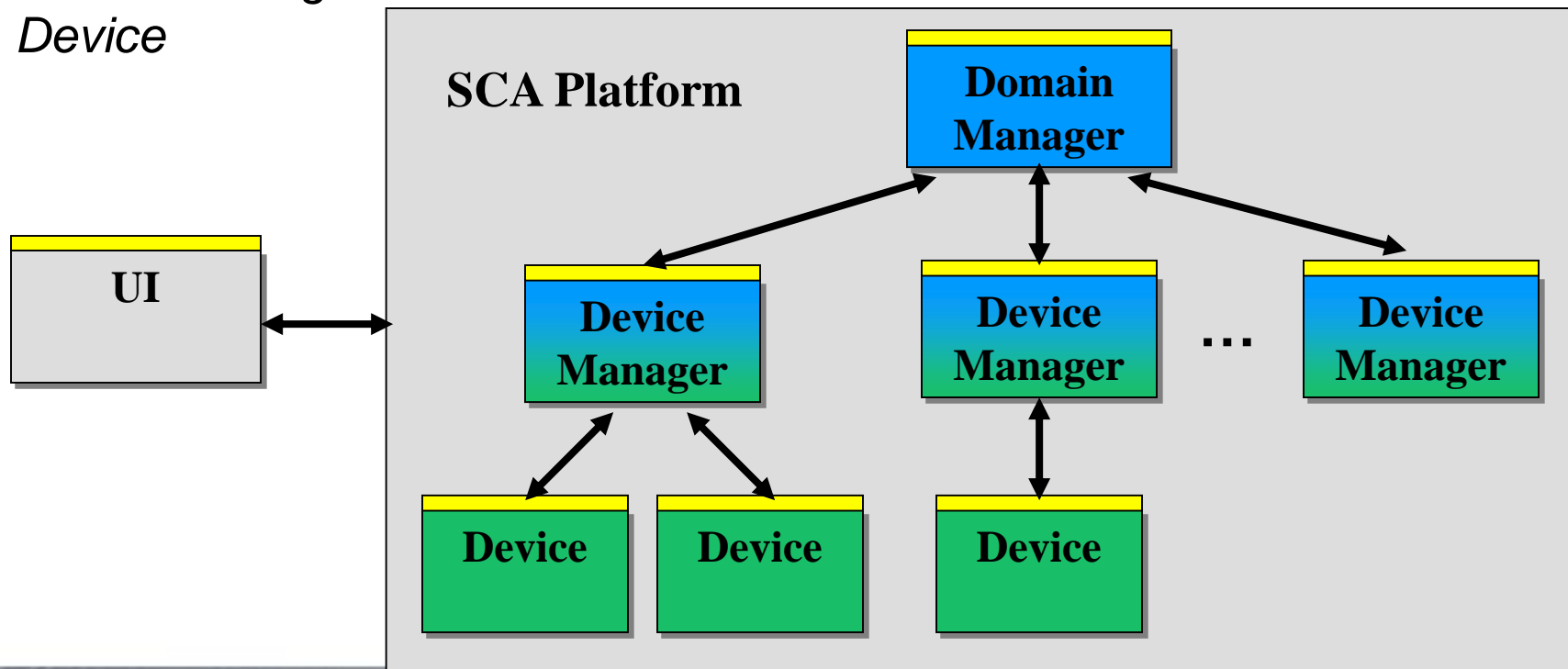

SCA Application

For an application developer, the SCA is composed of three major type of components:

- *Application Factory*
- *Application*
- *Resource*

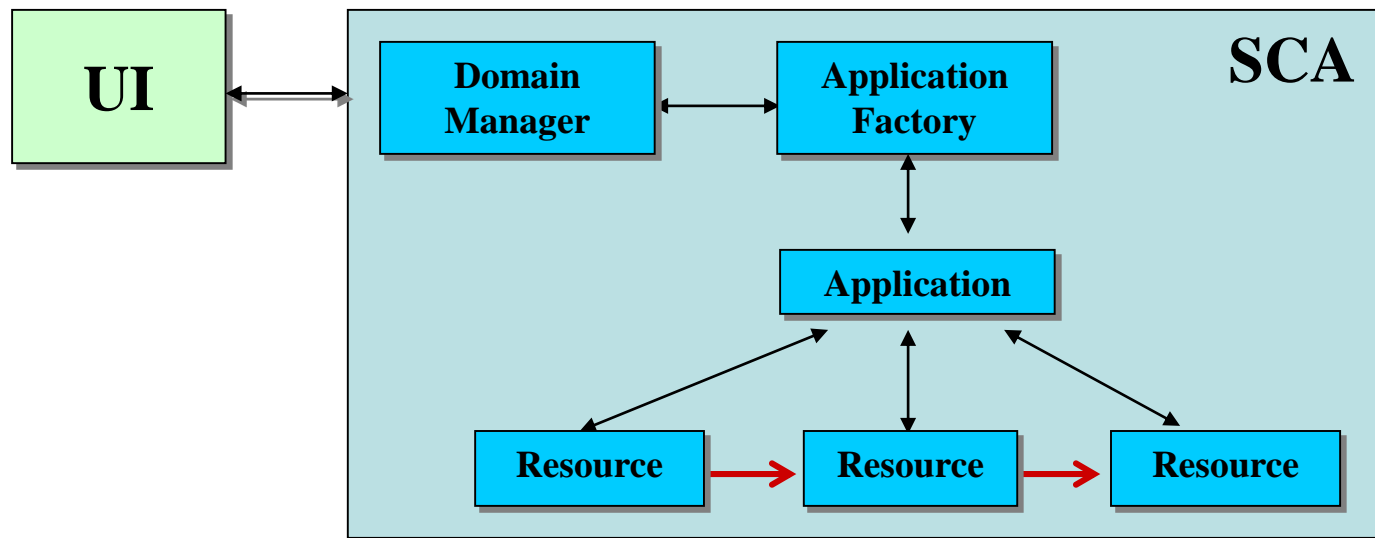

SCA Radio Platform

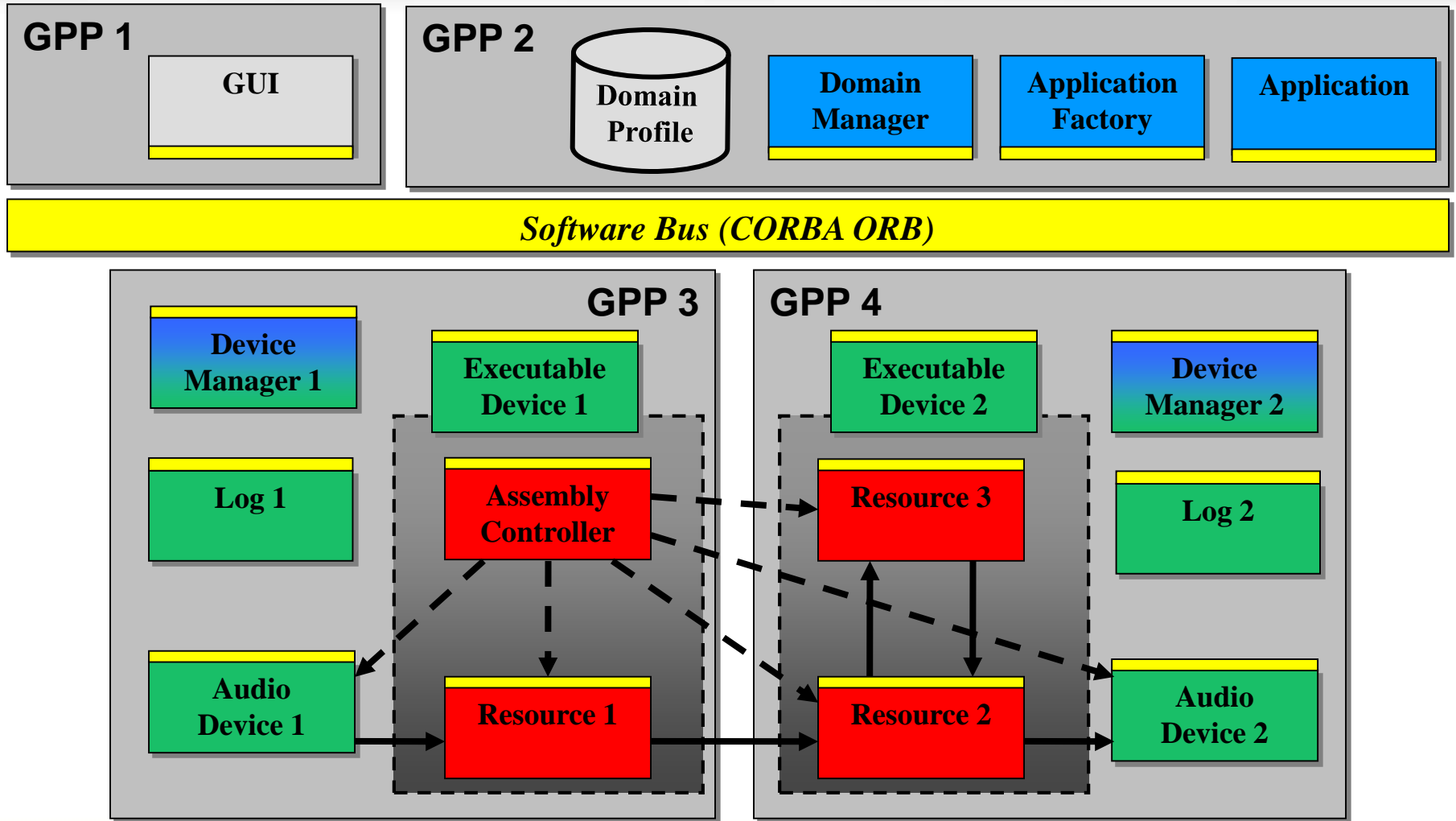

SCA Application Deployment

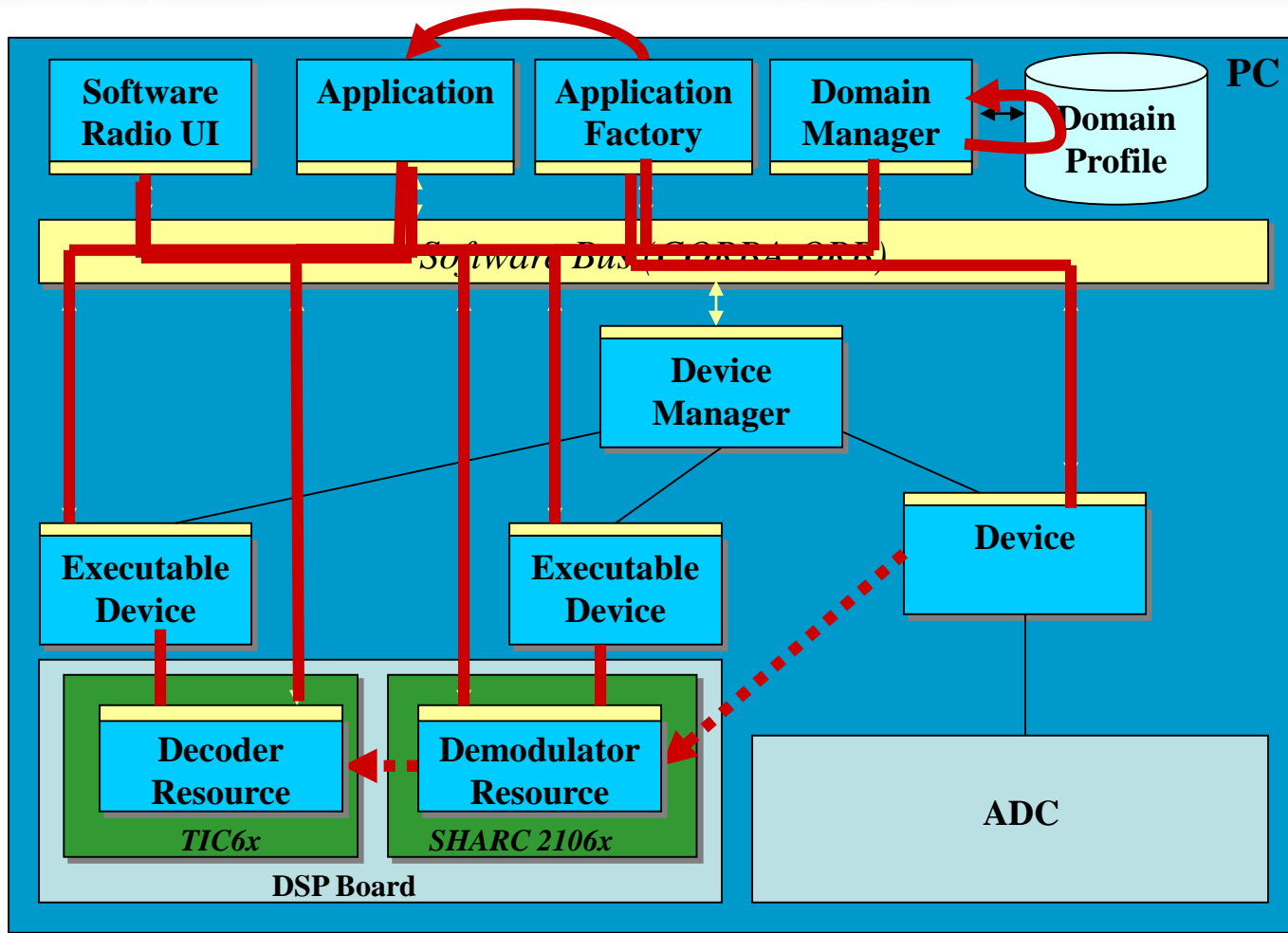

- **Software Defined Radio Characteristics**
 - Reconfigurability
 - Adaptability
 - Reuse of software

- **Cognitive Radio Characteristics**
 - Sense its physical environment surrounding via various sensors (GPS, meteorological, including RF)
 - Model-based reasoning engine
 - Rules for reasoning
 - Learning and adaptive capability

Cognitive Radio Simplified Architecture

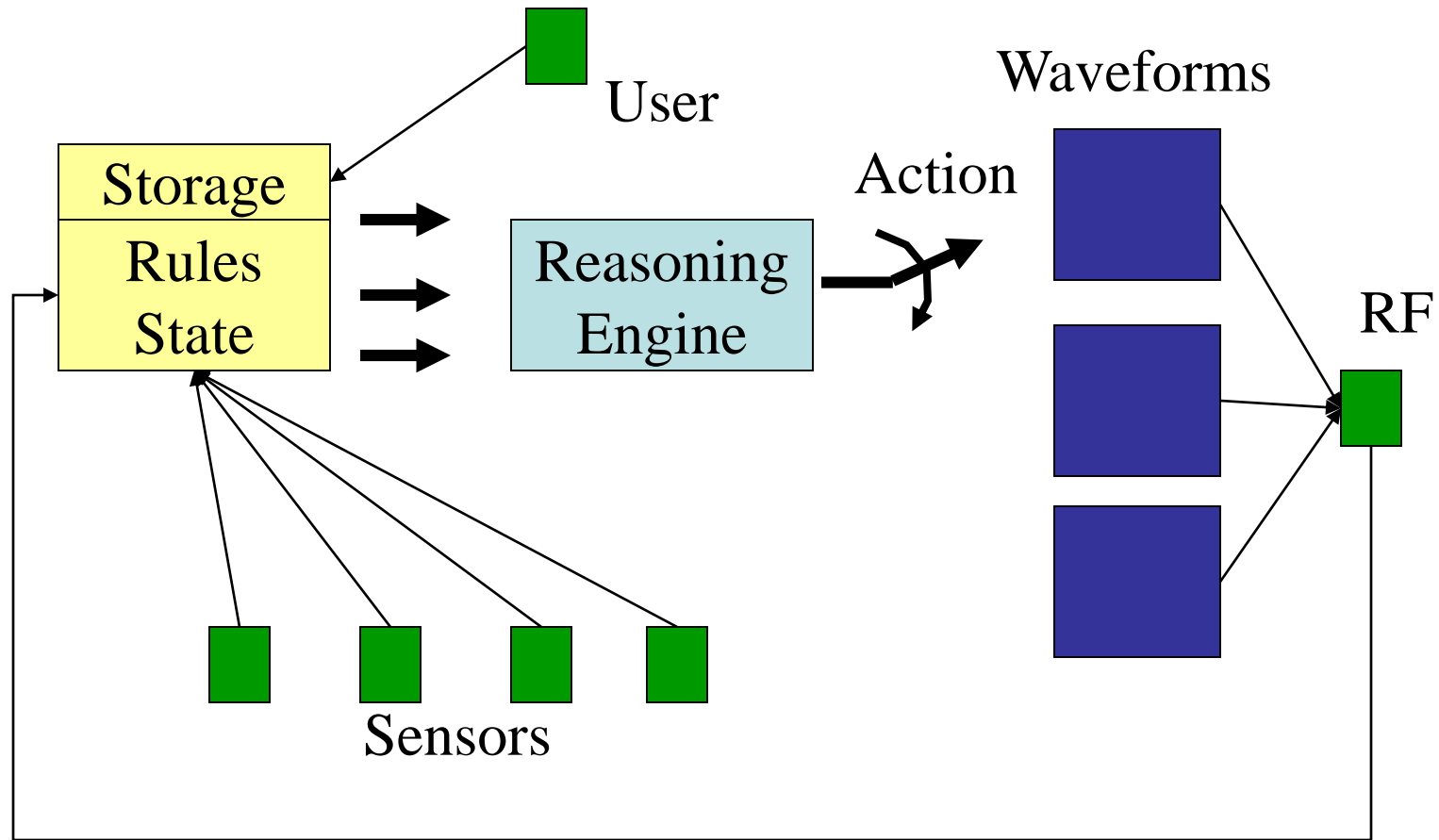

CSDR Makes Sense !

- **All the advantages for radio to be software defined are applicable to a cognitive radio**
 - Add flexibility of changing communication waveform or protocol
 - Instantiate application on the fly from a large pool of waveforms
 - Is adaptable in software to support new communication waveforms

CSDR Architecture

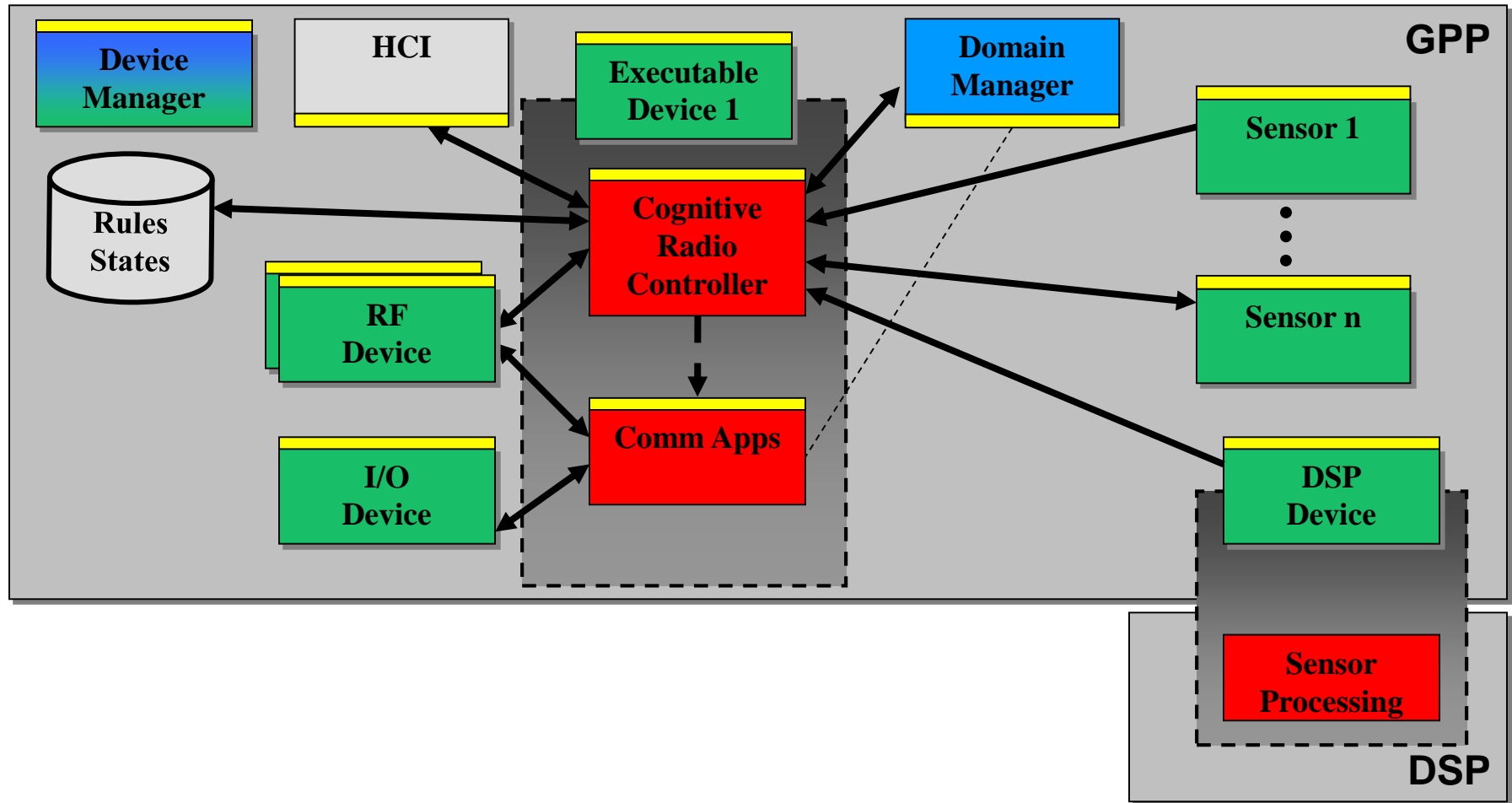

CRC and SDR

- CRC developed and Open Source Reference Implementation of the SCA (i.e. SCARI)
 - Over 7000 downloads worldwide
- CRC continues to develop software to promote the expansion of the Software Defined Radio

SDR Development Tools

- Waveform Application Builder (WAB)
- Waveform Optimizer
- Radio Manager
- Node Boot Builder

SCA Core Framework v2.2

- SCARI-2 (all Java)
- SCARI-2 Hybrid (Java and C++)
- SCARI++ (all C++)

Conclusion

- SDR offers the flexibility to reprogram the radio at will
- SDR Open Architecture allows
 - Third party development
 - Wider proliferation of the technology
 - Lower cost
- Merge of Cognitive functionalities into SDR
- CRC remains at the forefront of the technology development

Point of Contact

CRC SCA info

www.crc.ca/rmsc

info_scari@crc.ca